



Gesture Controlled Robot using Arduino and Android

Premangshu Chanda, Pallab Kanti Mukherjee, Subrata Modak, Asoke Nath

Department of Computer Science, St. Xavier's College(Autonomous),
Kolkata, West Bengal, India

Abstract— *The goal of gesture recognition in Computer Science field has always been the minimization of the distance between the physical world and the digital world. The way humans interact among themselves could be implemented in communication with the digital world by interpreting gestures via mathematical algorithm. Numerous ways and algorithms have been proposed and implemented to achieve the goal of gesture recognition and its use in communicating with the digital world. Gestures can be tracked using accelerometers. Since modern Smartphone are equipped with an in-built accelerometer, gesture control using Smartphone can be easy to implement, cheap to provide and the output will be more intuitive. This paper deals with the design and implementation of a wireless gesture controlled Robot using Arduino ATMEGA32 processor and an Android operated application to control the gestures via Bluetooth with minimal, and cheap hardware requirements. The system can be broadly classified into two components: The Hardware part consisting of Arduino Microcontroller, the Adafruit motor Shield, HC-05 Bluetooth module, and the Android Smartphone, and the software part consists of a Java based application run on android.*

Keywords—*Microcontroller, Accelerometer, Gesture recognition, Embedded Systems, Android, Bluetooth Module, Motor driver, Smartphone, Co-ordinates, Robot*

I. INTRODUCTION

Humans interact in the physical world by the means of the five senses. However, gestures have been an important means of communication in the physical world from ancient times, even before the invention of any language. In this era of machines taking control of every complex works, interactions with machines have become more important than ever. Robots are classified into two types: Autonomous robots like Line sensing or edge sensing robots, and Remote controlled robots like Gesture controlled Robots. Since this paper deals with gesture controlled robot, the primary focus will be on the remotely controlled robots only.

Undoubtedly, the output and the functioning of machines will be more intuitive if they are communicated using human gestures. A gesture is a form of communication in a non-verbal manner by using visible body movements or actions conveying messages.

There are several ways to capture a human gesture that a machine would be able to understand. The gesture can be captured using a camera, or a data glove. Gestures can also be captured via Bluetooth or infrared waves, Acoustic, Tactile, optical or motion technological means [1]. The embedded systems designed for specific control functions can be optimized to reduce the size and cost of the device, and increase the reliability and performance. With the advent of Smartphone and other modern technologies, operating machines have become more flexible. The Smartphone are equipped with in-built accelerometer which may be used for gesture recognition and such other tasks. Moreover, the Android OS is gaining significant popularity in the world of Smartphone due to its open architecture. Android platform is being used in the development of numerous applications for cell-phones.

Researchers have shown interest in gesture recognitions and have built several robots and devices that are controlled by human gestures. There is a constant development in the field of gesture controlled devices. Apart from hand gesture recognition, emotional gesture recognition from face is also done in some cases. There are two types of gestures used in gesture recognition: Online gestures and Offline gestures. In Online gestures, direct manipulations like rotation and scaling are done. In Offline gestures, the processing is done only after the user interacts with the object. Gesture technologies are applied in several fields like in Augmented Reality, Socially assistive Robots, recognition of sign languages, emotion detection from facial expressions, Virtual mouse or keyboard, recognition of sign languages, remote control, etc.

There are various modes of communication between the microcontroller of the robot and the Smartphone. However, the popularly used means of communication is done via RF, Bluetooth or Wi-Fi. Using RF limits the distance from which the robot can be controlled. Using Wi-Fi increases the overall cost for setup. So, the robot has been built with Bluetooth which has intermediate range of distance covered and cost between RF and Wi-Fi.

In this paper, an android operated phone is incorporated as an accelerometer as well as the platform for the Java application to execute. The Arduino microcontroller is incorporated in the robot for the main computation and the main communication between all the modules. Then there is a motor driver that deals with the computation and functioning of the motors to turn the wheels essential for the movement of the robot. Last, but not least, a Bluetooth module is incorporated in the robot that serves as the means of receiving the data from the Smartphone which is processed in the

Arduino to detect the direction of movement of the user's hand and move the robot accordingly. The prime aim of the design is that as the user moves his hand in some direction, the robot moves in the same direction as well. In other words, the robot is solely controlled by the hand movements and gestures of the user. The goal of this paper is to develop a method to control and program a robot with gestures and assure high level of abstraction, cheap and minimal hardware and a simplified robot programming.

II. RELATED WORKS

The emergence of robots can be traced back to the 90's with Helpmate Robots and Robot-Caddy [1]. Since then, there is an exponential development in the field of robotics, and controlling robots through human gestures have been the topic of research for as long time. With the implementation of gestures to control robots, there have been several methodologies to perform the action. Some of the related works are being described in this section:

A. Light-based Gesture Recognition

Light or illumination tracking and controlling robots with light sensors are being done in a lot of cases. Such robots are autonomous in nature. Generally, there are some light sensors associated with the robot. The sensors send some rays of light and track them as they get absorbed in the surface or reflected back to it. According to this, the robot can be line-sensing robots where it is made to follow a black or a white path autonomously.

B. Vision-based Gesture Recognition [7]

Several robots are designed to be controlled by vision-based gestures. In such robots, there are, generally, some cameras as the sensor, which also acts as an interface to control the robot with some manipulators. The input gesture can be some patterns, movements of hands, color tracking, face recognition, finger tracking, or some templates. They are also used in ball tracking and Robo-football games where the robots play the traditional game of football by tracking the movement of the ball. Though it has paved a way for advanced robot operations, but it is affected by factors such as illumination, foggy weather, background lights, etc. [2]

C. Motion-based Gesture Recognition

The motions can be used to control a robot. This is generally done by incorporating an accelerometer to control the robot wirelessly. This can also be done using sensors. This method is beneficial over other methods in the sense that it can interact with machines naturally without being intruded by the factors that affects the mechanical devices [3]. One important development in this field is done by Sauvik Das et al in 2010, where he designed a spying device yielding location and activities of the user without his/her knowledge [4].

D. Sixth Sense Technology

The Sixth sense technology begins in 1990 by Steve Mann who implemented a wearable computing device via neck-projector or head-mounted projector coupled with a camera. Later, following his idea, Pranav Mistry, a young research scientist at MIT at that time came up with new applications of this technology. Pranav Mistry came up with the name 'Sixth Sense Technology' and has since been named Wear Ur World (WUW). This technology applies all of the techniques mentioned above and designing applications that give an intuitive output with the connection of internet.

III. TECHNICAL REQUIREMENTS

In this work, there are six fundamental components are required as shown in the figure 1.

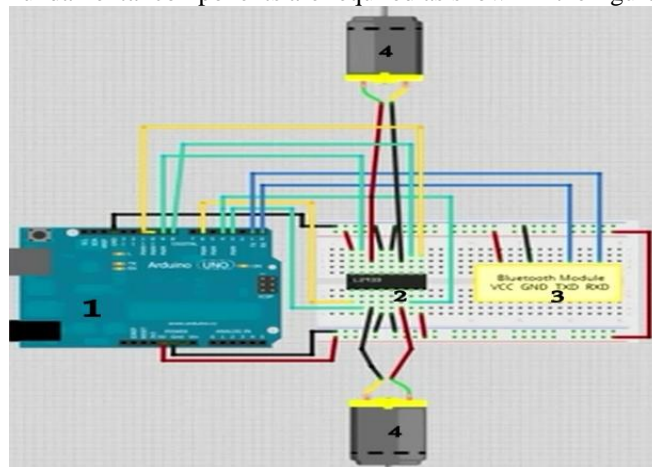

Figure 1: Technical Components used in the work

A. Microcontroller

The first requirement for the design of the robot is the microcontroller. In this work, Arduino ATMEGA 328 has been used. It is an open-source electronics prototyping platform with 14 digital I/O pins, 6 analog inputs, 16 MHz crystal oscillator, a USB connection, a power jack, an ICSP header and a reset button. In figure 1, it is marked with 1 [8].

B. Mechanical Components

Motor driver is an additional requirement in this work. But to make the output more intuitive, this component is necessary. DC motors are used in this work to rotate the four wheels due to its effectiveness while designing robot with a high gear ratio. The motors are shown in the figure as 4. The motor shield used here is Adafruit Motor Shield V2. The chip marked as 2 in the figure is motor shield, though a commercial manufactured motor driver is used to complete the work.

C. Bluetooth Module

Bluetooth is a global standard for Bluetooth connectivity. This is an essential component in this work. This module connects the microcontroller and the Android Smartphone for data exchange. The module used here is HC-05 Bluetooth module. It is an easy to use Bluetooth SSP with typical -80dBm sensitivity, up to +4dBm RF power, low power 1.8V operation and several software properties that facilitates the connectivity [9]. In figure 1, it has been denoted by 3.

D. Android Smartphone

This is the remote components that senses the user's hand movements and send its determinant value to the Arduino microcontroller via the Bluetooth module. The Android application designed for this work does the calculation of the determinant.

IV. SYSTEM DESCRIPTION

Gesture recognition is the main aim of this work. The user holds an Android operated Smartphone, and moves, or rotates his hand in any direction. The accelerometer within the phone is regulated to generate a maximum and minimum value for the movement of the hand in three dimensional co-ordinates depending upon the external environmental conditions. The android application does the work of sensing the accelerometer calibration and generating the maximum and minimum values from it. Depending upon the values obtained, it sends a determinant value to the microcontroller using Bluetooth. The Bluetooth module receives data and transmits it to Arduino where it checks the determinant value and moves the robot accordingly. The whole process is under an infinite loop, so it runs as long as the power is supplied. The output depends on the accelerometer inputs directly that can be used to control the robot. The accelerometer input depends on the gestures of the user's hand.

The steps stated above are broadly described in this section. The system consists of the following steps to work as mentioned:

A. Block Diagram of the system

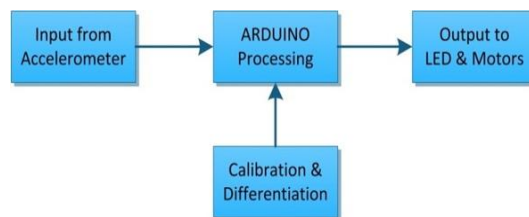

Figure 2: Block diagram of the system

B. Transmission of data from Android application to Motor driver

The input to the application is the direction of movement of hand of the user given by the accelerometer. This is analog in nature. It is then digitally coded by the Android application before sending it to Arduino by HC-05 Bluetooth module. The signal goes to the digital pins of the Arduino board, which has an inbuilt AD/DA converter of 8 bit. The Arduino process the received data. Based on the data received, appropriate signal is transmitted to the motor driver to rotate the motor in such a way that the robot moves in the direction of movement of the user's hand.

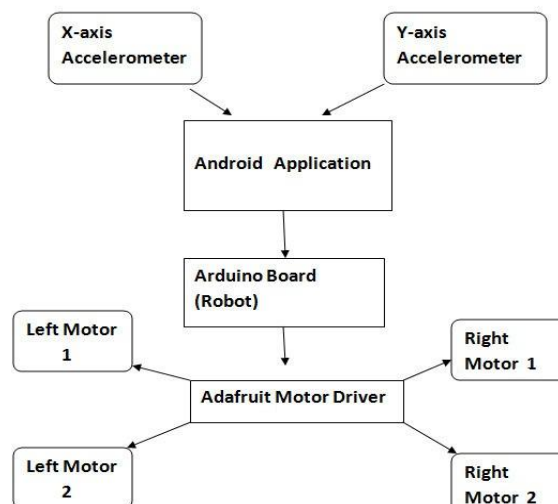

Figure 3: Transmission of data

C. Receiving the data

The data is received from the Android Smartphone via HC-05 Bluetooth module on the digital pins of the Arduino microcontroller. It is then processed in Arduino. This processed data is received by the Adafruit motor shield. Based on the data

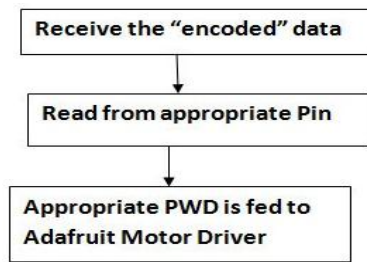

Figure 4: Receiving the data

D. Gesture Recognition

Android Smartphone's are equipped with inbuilt accelerometers. The application designed in this work retrieves the value of the accelerometer and sends a determinant value to the microcontroller via Bluetooth. As the user moves his hand, the accelerometer reading changes. It is then retrieved by the application. There are two values: One is maximum value and the other is minimum value. The range is specified using these two values for each function of the robot. If the value retrieved by the application lies between these specified values, then the corresponding determinant is generated. This determinant is sent to the microcontroller, which then receives the determinant value, process it to recognize the corresponding gesture, and sends signals to move the robot accordingly.

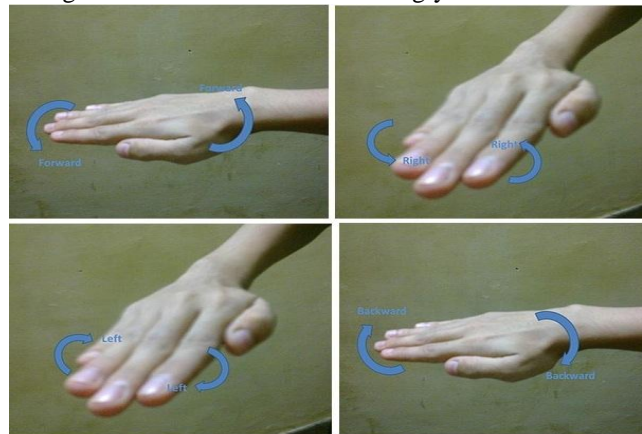

Figure 5: Gestures for movement of the robot

Figure 5 shows the gestures to control the movement of the robot. When the user tilts his hand forward, the gesture is recognized as the forward movement, and the robot moves in the forward direction. The angle of the tilt or the difference between the angle of tilt of user's hand and the threshold value of forward movement gesture determines the speed of the robot. When the user tilts his hand on the right direction, the gesture is recognized as the right turn, and the robot moves in the right direction. When the user tilts his hand in the left direction, the gesture is recognized as the left turn, and the robot moves in the right direction. The angle of the tilt of user's hand determines whether the left or right turn is a normal turn or a sharp turn. A sharp turn is one in which a car changes direction without slowing down before turning. When the user tilts his hand backwards, the gesture is recognized as the move backward gesture, and the robot moves in the backward direction. If the user's hand is somewhere between the two gestures, i.e., the accelerometer value is somewhere between the threshold of two directions(forward and left turn, left turn and backwards, backwards and right turn, forward and right turn), then the robot moves in that diagonal direction.

E. Movement of Motors and Wheels

There are four DC motors used in the design of this robot: one motor for each wheel. The motors are controlled by the Adafruit motor shield. The shield is stacked on top of Arduino. Every shield stacked can run 4 DC motors. Installing the Adafruit Motor Shield library gives the flexibility of using the motors just by calling some pre-defined functions as `motor1.setSpeed(value)` that sets the speed of the motor to 250 rpm, or `motor1.run(FORWARD)` that makes the motor1 to rotate forward [10]. These functions are called from the program burnt in the Arduino microcontroller. The signal is sent to the motor shield that runs the motors.

The wheels are connected to the motors. 4 DC motors are used Two for left wheels, and two for right wheels. When the signal received in the motor shield is to move forward, all the four wheels of motors rotate forward, this turns all the four wheels in the forward direction. The robot moves in the forward direction. When the signal received in the motor shield is to turn the robot in the forward left direction, the left diagonal motors are rotated backwards while the right diagonal motors are made rotated forwards. This makes the robot turn in the forward left direction. When the signal received in the motor shield is to turn the robot in the forward right direction, the right diagonal motors are rotated

backward while the left diagonal motors are rotated forwards. This makes the robot turn in the forward right direction. When the signal in the motor shield is to move backward, both the pairs of the motors are rotated backwards resulting the robot to move backwards. When the signal in the motor shield is to stop the robot, all the motors are made stationary resulting the robot to stop.

Similarly, to rotate the robot in backward directions, similar methodology is used. To turn the robot in the backward left direction, the left diagonal motors are rotated forwards while the right diagonal motors are rotated backwards. This makes the robot turn in the backward left direction. To turn the robot in the backward right direction, the right diagonal motors are rotated forwards while the left diagonal motors are rotated backwards. This makes the robot turn in the backward right direction...

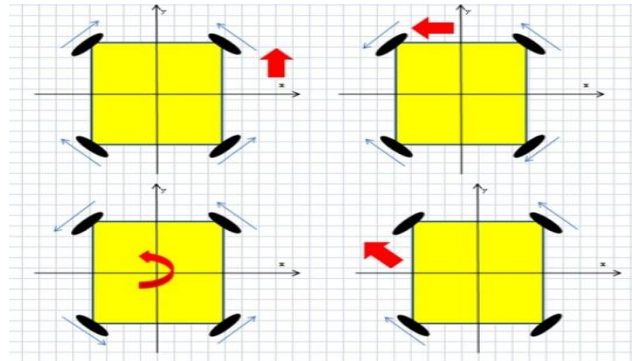

Figure 6: Movement of the Motors and Wheels

F. Designing the Android Application

The Android application is the key to control the robot using hand gestures. The application reads the accelerometer state and X, Y, and Z values are obtained in the application. There are two threshold values assigned for each movement: one is the MAX_THRESHOLD, and the other is the MIN_THRESHOLD. If the obtained value lies between these thresholds of a certain movement, then the character assigned to denote that movement, which is called the DET or determinant is sent to the robot via Bluetooth. The application continuously sense this until the application is ON. A graphical user interface has been designed for the comfort of the user. The application abstracts the calculations and accelerometer values, but the user interface shows the direction of movement of the hand so that the user is aware of wrong turns in the bot.

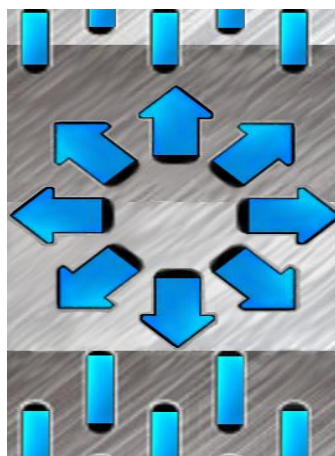

Figure 7(a): Screenshot of the Android application at the default state

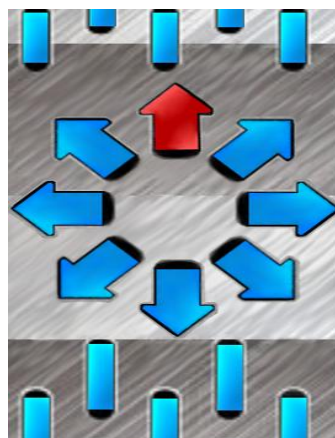

Figure 7(b): Screenshot of the Android application when the user moves his hand forwards

V. ALGORITHM FOR GESTURE CONTROLLED ROBOT

A. Main Module

Step 1: Initialize the frequencies of the motors.

Step 2: Initialize SERIAL 9600

Step 3: Set the speed for the motors in rpm.

Step 4: While (1) do

1. DET \leftarrow check();
 2. While DET == F, move the robot forward
Call check();
End While
 3. While DET == B, move the robot backwards
Call check();
End While
 4. While DET == L, move the wheels left
Call check();
End While
 5. While DET == R, move the wheels right
Call check();
End While
 6. While DET == I, move the wheels right forward
Call check();
End While
 7. While DET == J, move the wheels right backward
Call check();
End While
 8. While DET == G, move the wheels left forward
Call check();
End While
 9. While DET == H, move the wheels left backward
Call check();
End While
- End While

B. Function check()

Step 1: Initialize DATAIN \leftarrow S

Step 2: Initialize VELOCITY \leftarrow 0

Step 2: If data on the serial lines $>$ 0 then

1. DATAIN \leftarrow Character sent by the phone
 2. If DATAIN == F, then DET \leftarrow F
 3. If DATAIN == B, then DET \leftarrow B
 4. If DATAIN == L, then DET \leftarrow L
 5. If DATAIN == R, then DET \leftarrow R
 6. If DATAIN == I, then DET \leftarrow I
 7. If DATAIN == J, then DET \leftarrow J
 8. If DATAIN == G, then DET \leftarrow G
 9. If DATAIN == H, then DET \leftarrow H
 10. If DATAIN == S, then DET \leftarrow S
- End If

Step 3: Set the velocity based on the data received in the multiples of 25. Set VELOCITY \leftarrow U, if no valid value for velocity is received.

Step 4: Return DET

VI. ALGORITHM FOR THE ANDROID APPLICATION

Step 1: Connect to the Bluetooth Module

Step 2: Set THRESHOLD_MAX and THRESHOLD_MIN values for each direction forward, backward, Left and Right

Step 3: Get the state of the accelerometer:

I \leftarrow State of the accelerometer

Step 4: VALUE \leftarrow I into X,Y,Z coordinate values

Step 5: If VALUE is in between THRESHOLD_MAX and THRESHOLD_MIN for a direction, then set DATAOUT as the direction of VALUE represented by a Character.

Step 6: Return DATAOUT

VII. EXPERIMENTAL RESULTS

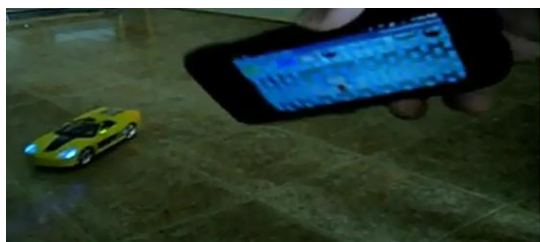

Figure 8: The robot moves in the direction of the movement of the user's hand: forward-left



Figure 9: The robot moves in the direction of the movement of the user's hand: back

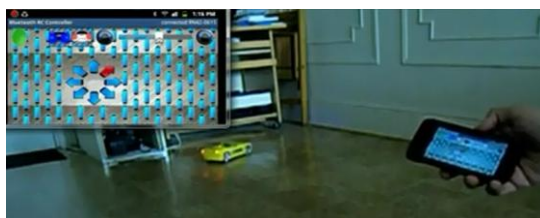

Figure 10: The robot moves in the direction of the movement of the user's hand: forward –right

VIII. FUTURE SCOPE AND CONCLUSION

The Gesture controlled robot designed in this work has many future scopes. The robot can be used for surveillance purpose. The robot can be applied in a wheelchair where the wheelchair can be driven by the movements of rider's hand. Wi-Fi can be used for communication instead of Bluetooth to access it from a greater distance. Edge sensors can be incorporated to it to prevent the robot from falling from any surface. Some camera can be installed which can record and send data to the nearby computer or cell-phone. It can be implemented on a watch, or in any home appliances like Room heater. Modern ARDUINO chips support Intranet as well as Internet connections which can be utilized to a greater extent. This robotic car can be enhanced to work in the military surveillance where it can be sent to some enemy camps and track its activities via Internet. With a mind full of creation, the possibilities are endless.

In this paper, the design and implementation of Gesture Controlled Robot is presented and developed using Arduino microcontroller and Android Smartphone. An algorithm has been provided and its working is detailed thoroughly. Since the updating possibilities are endless, updating the system has been kept as a future scope. The built device is cheap, and is easy to carry from one place to another. The addition of the some additional sensors or camera will make it more productive. The limitation of the hardware being associated with a system has been reduced to a great extent. As an end thought, the system will allow the user to control it in a way that reduces the gap between the physical world and the digital world with an output more intuitive.

REFERENCES

- [1] Monika Jain, Aditi, Ashwani Lohiya, Mohammad Fahad Khan, Abhishek Maurya "Wireless Gesture Control Rbot: An Analysis" Available at: <http://www.ijarce.com/upload/december/22-WIRELESS%20GESTURE.pdf>
- [2] Wang, B., and Yuan, T., "Traffic Police Gesture Recognition using Accelerometer", IEEE SENSORS Conference, Lecce-Italy, pp. 1080-1083, Oct. 2008.
- [3] Cannan, J. and Hu, H., "Human-Machine Interaction (HMI): A Survey".[Online]. Available: <http://www.dces.essex.ac.uk/staff/hhu/Papers/CES-508%20HMI-Survey.pdf>
- [4] Song, M., Kim, B., Ryu, Y., Kim, Y., and Kim, S., "A design of real time control robot system using android Smartphone" The 7th International Conference on Ubiquitous Robots and Ambient Intelligence (URAI), Busan-Korea, Nov. 2010.
- [5] K. Brahmani, K. S. Roy, Mahaboob Ali, April 2013, "Arm 7 Based Robotic Arm Control by Electronic Gesture Recognition Unit Using MemS", International Journal of Engineering Trends and Technology, Vol. 4 Issue 4 Available at: <http://www.ijettjournal.org/volume-4/issue-4/IJETT-V4I4P347.pdf>
- [7] S. Waldherr, R. Romero and S. Thrun, 2000, "A gesture based interface for human-robot interaction", In Autonomous Robots in Springer, vol. 9, Issue 2, pp. 151-173 Available at <http://www.cs.cmu.edu/~thrun/papers/waldherr.gestures-journal.pdf>

- [8] Available: <https://www.arduino.cc/>
- [9] Available: [http://wiki.iteadstudio.com/Serial_Port_Bluetooth_Module_\(Master/Slave\)_:_HC-05](http://wiki.iteadstudio.com/Serial_Port_Bluetooth_Module_(Master/Slave)_:_HC-05)
- [10] Available: <http://learn.adafruit.com/adafruit-motor-shield-v2-for-arduino>
- [11] Ying Wu and Thomas S. Huang, "Vision-Based Gesture Recognition: A Review", In: Gesture-Based Communication in Human-Computer Interaction, Volume 1739 of Springer Lecture Notes in Computer Science, pages 103-115, 1999, ISBN 978-3-540-66935-7,doi:10.1007/3-540-46616-9
- [12] R. Cipolla and A. Pentland, Computer Vision for Human-Machine Interaction, Cambridge University Press, 1998, ISBN 978-0-521-62253-0
- [13] Matthias Rehm, Nikolaus Bee, Elisabeth André, Wave Like an Egyptian - Accelerometer Based Gesture Recognition for Culture Specific Interactions, British Computer Society, 2007
- [14] Michael Barr. "Embedded Systems Glossary". Neutrino Technical Library. Retrieved 2016-06-03
- [15] Saurav Biswas, Umaima Rahman, Asoke Nath "A new Approach to Control a Robot using Android Phone and Colour Detection Technique", International Journal of Computer Science and Information Technologies(IJCSIT), Vol.6(3), Page 2985-2989(June 2015)