



## Planning a Smart Network Design in Home Networking: A Survey

Sheikh Raashid Javid\*

Deptt of CE/IT, RK University  
India.

Sheikh Mohsin Pervez

Deptt of CS, Rayalaseema University  
India.

**Abstract**— This paper relates various network designs and the benefits of a smart network design in home networking. With the widely growth of broadband technology, there is an increase in the number of ISPs and the home network equipment manufacturers. Thus planning a network properly proves to be a cost-effective. This paper begins with various possible network designs and how to plan an economical and smart network design in home networking. Thus different types of network designs and the advantage of various internet connections discussed in this paper can help a home network user to choose a particular internet connection and plain a home network effectively and efficiently.

**Keywords**— ISP, Network Design, Download speed, setup cost, Dial-up, DSL, Cable.

### I. INTRODUCTION

There is a tremendous increase in the number of home network users, mainly because of the increase in the number of computers due to lower price. Also due to advancement and improvement in networking technologies it is beneficial to distribute high speed internet connection among multiple computers. Other benefits of home networking include file sharing, printer sharing, multi-media sharing and enhanced entertainment. Since there are various types of internet connections provided by various ISP, thus it's very important to choose an internet connection which offers high speed with low cost in comparison with other ISPs. The internet connection should also provide cheap technical support and less installation cost. Various network equipments should be used to take the advantage of cost involved in using the various services provided by an ISP. The main criteria to choose a particular internet connection is the download speed offered by an ISP, and the cost involved to setup and maintain a particular network connection.

This paper is divided in to 5 sections, Section 1 begins with the need of planning a home network, different types Network Designs in home networking are covered in Section 2, Section 3 discusses different criteria to plan a home network, suggestions of choosing an ISP is briefly covered in Section 5 and Section 6 concludes the various benefits and advantages of planning a home network design properly.

### II. TYPES OF NETWORK DESIGN

Home Area Networks can be planned using various network designs. Each network design has its advantages and disadvantages. The main idea is to design a cost effective network design in home networking which is scalable to future changes and lasts for a long time.

#### Ethernet Network Design:

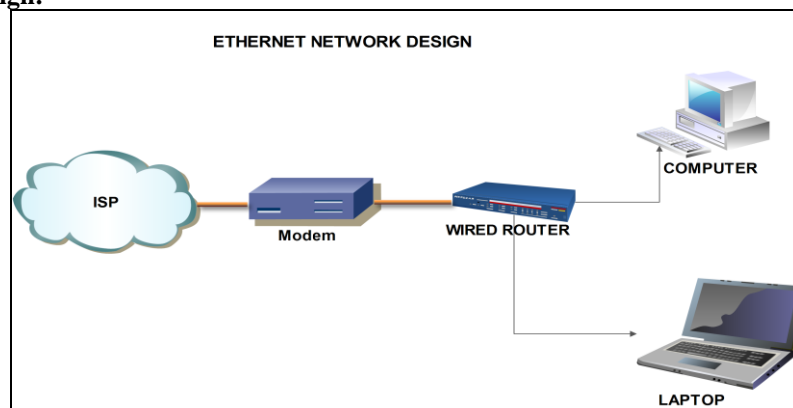

Ethernet Network Design

In an Ethernet Design, all the computers are connected to a router or modem with an Ethernet cable. The main advantages of an Ethernet Design is that it is easier and quicker to setup this network, the speed is faster and can reach up to 1000Mbps when compared with wireless networks where a speed can reach up to 100Mbps. But there is lack of mobility and the problem in running the wires.

**Wireless Network Design:**

Computers connect wirelessly to a wireless router. The main advantage of a wireless network design is that it eliminates the need for cables and a user can move freely with a laptop inside a home. Also the latest gadgets have wifi access and they can be easily connected to the wireless network. The main problem is that there is a limited coverage, also data security should be maintained and it involves some technical knowledge to setup this network.

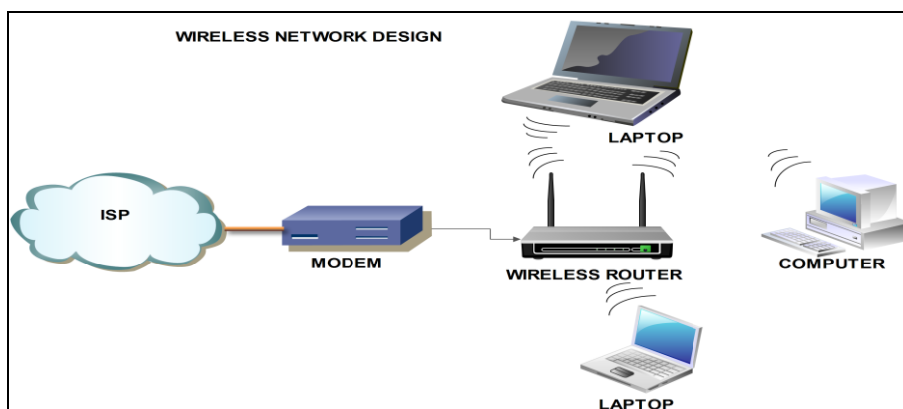

**Wireless Network Design**

**Computer-to-Computer Network Design:**

The main advantage of computer-to-computer network design is that it is more economical because there is no need of a central device or a router, internet access can be given to one computer and shared among other computers, it is also known as ad hoc network. The main disadvantage of this design is that it doesn't have all the features of a router, thus it is less secure and this design is not recommended to be used in a large network due to problem in managing a network.

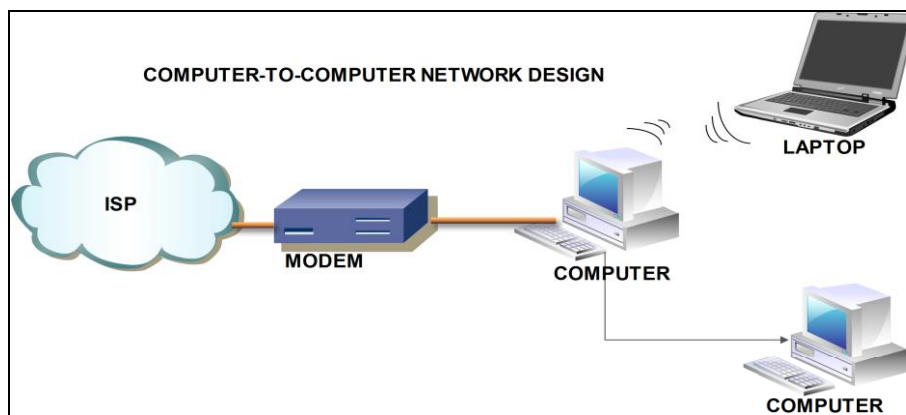

**Computer-to-Computer Network Design**

**Power or Phone Line Network Design:**

This type of network design makes use of power or phone lines to send internet signal to other computers inside a home. The main advantage of this design is that the size of a home network can be extended to provide internet access to other computers and wifi enabled devices within a home..

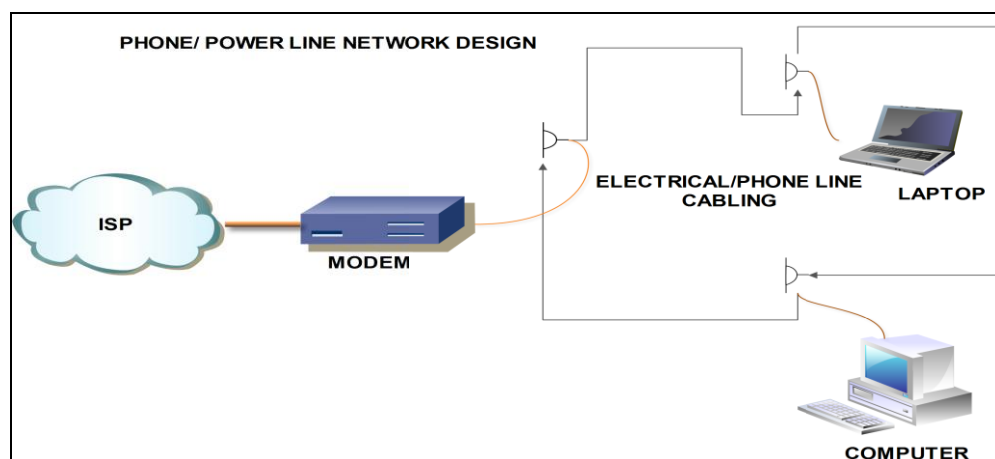

**Power or Phone Line Network Design**

Hybrid Network Design:

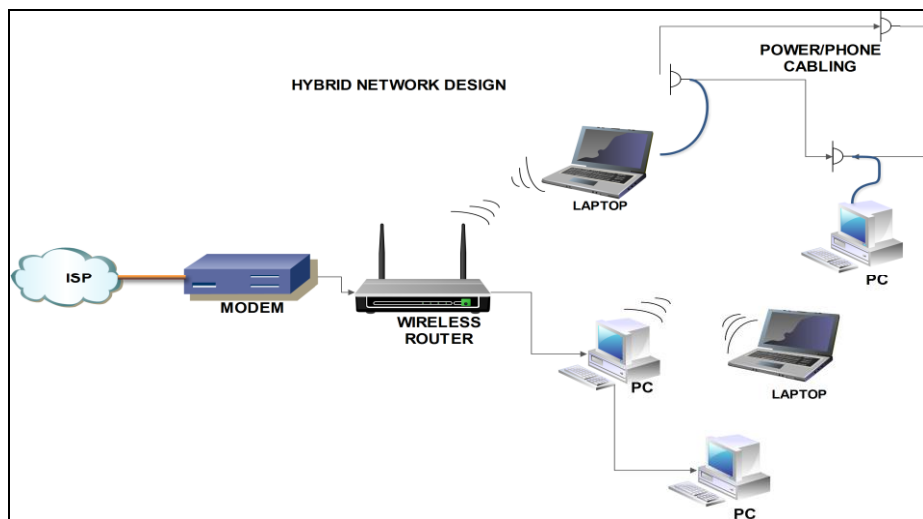

Hybrid Network Design

The main idea of a hybrid network design is to combine the advantages and features of all the network designs into a single network design, the network can be extended in size and the internet access will be provided to all the computers within a home. The computers which can't be connected to a router can get internet access through power or phone line cables. Thus hybrid network design is one of the best solutions to plan a network design efficiently and economically within a home.

III. PLANNING HOME NETWORKS

Planning and choosing a network design in home networking is a challenging job and if planned properly can save lot of money. Due to tremendous growth in Broadband Technology, increase in the number of ISPs, and improvement in the design of various home network equipments with decrease in price, there are various internet connections available to a user. The main criteria to choose an internet connection is the download speed offered by an ISP and the maximum monthly cost involved to setup and maintain a particular type of internet connection.

Maximum Download Speed

There are various types of internet connection offered by an ISP, planning and choosing a particular type of internet connection depends on the maximum download speed needed by a home network user. We can roughly compare the download speed offered by various ISPs in different types of internet connections, the download speed offered by these Internet connections may further vary depending on the type of cable, type of networking devices and the distance from the ISP. But it gives a rough idea while comparing different types of internet connections. As can be seen from the table that the cable costs about 5 times the cost of dialup connection but speed of cable connection is almost 70 times faster than the dialup connection. DSL and Cable Internet connections are the mostly widely types of Internet connection used in homes nowadays.

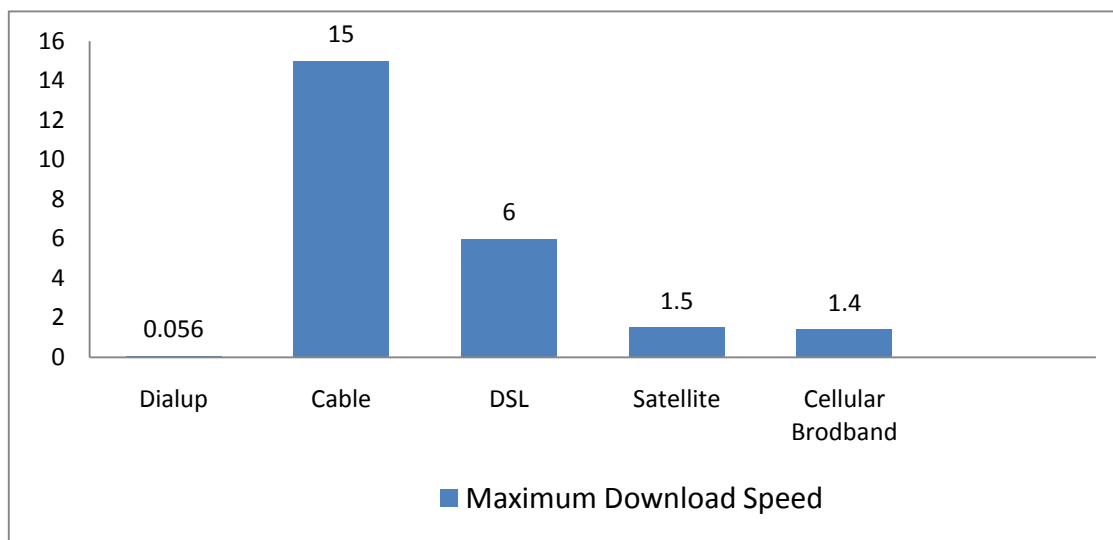

Maximum Download speed of different connections

**Maximum Setup Cost and Monthly Cost:**

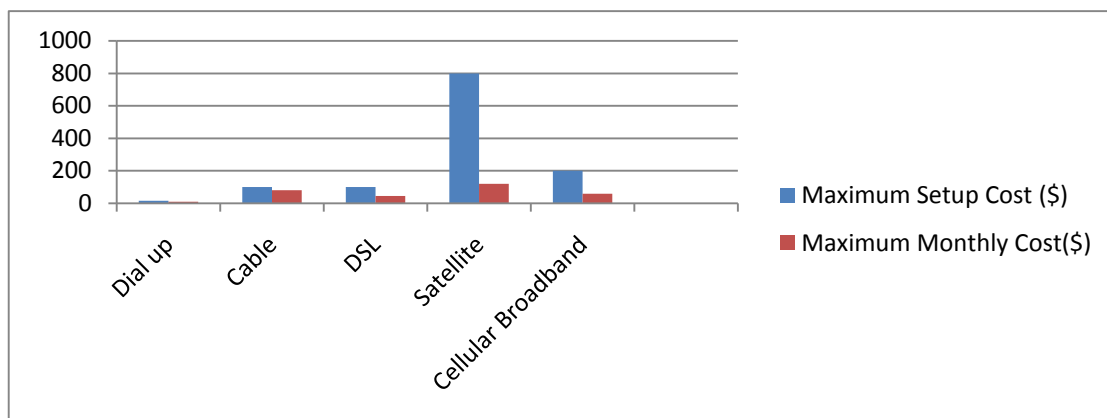

**Maximum Setup Cost and Monthly Cost of different internet connections**

Another important criterion to keep in mind while planning an Internet Connection is the Maximum setup cost and Monthly cost involved in selecting a particular internet connection. If a setup cost is little higher but the monthly cost should be as low as possible to maintain a particular internet connection. After comparing the setup cost and monthly cost involved in various connections in home networking, we conclude that the DSL service is available at the lower price when compared with Cable connection, but offers little lower speed. However DSL service is not shared among multiple users and also there are various service levels offered by an ISP.

**IV. CHOOSING AN ISP**

Nowadays there are various ISPs offering various internet connections with various benefits and offers. Thus it is very important to choose an ISP depending on type of internet connection, equipment, installation charges, and tech support etc. While China is home to the largest broadband service provider in the world and the two Chinese ISPs China Telecom and China Unicom, account for nearly 20 percent of the world’s broadband subscribers. The United States had four broadband ISPs in the top ten lists: Comcast, AT&T, Time Warner Cable (c TWC) and Verizon, these top 10 broadband service providers in total account for roughly 39 percent of world’s total broadband customers. Thus it is better to choose an ISP which offers various benefits and service levels and which has large number of customers. Among various ISPs,

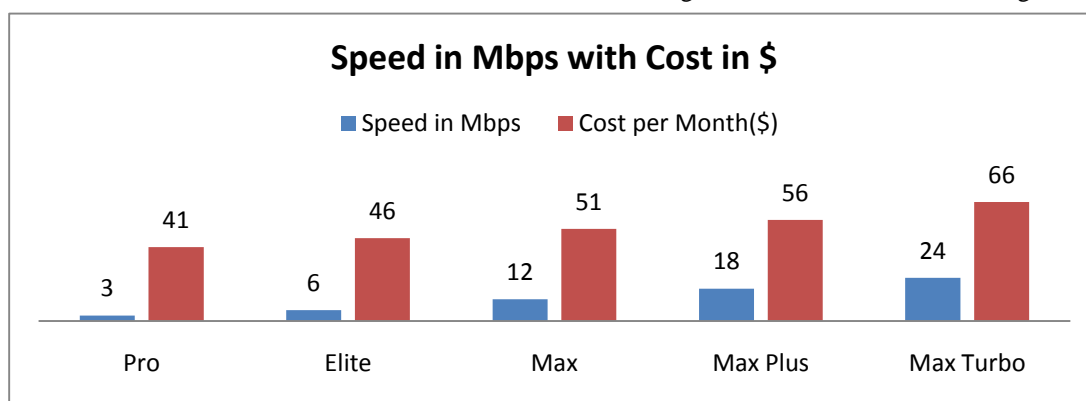

**Different Internet Packages offered by AT&T**

AT&T is recognized as one of the leading worldwide providers of IP-based communications services to businesses, having the nation's largest 4G network — covering 275 million people, and 2,000 more 4G cities and towns than Verizon, and the largest international coverage of any U.S. AT&T operates the nation's largest Wi-Fi network including more than 30,000 AT&T Wi-Fi Hot Spots at popular restaurants, hotels, bookstores and retailers, and provides access to more than 220,000 hotspots globally through roaming agreements. Thus the brand of an ISP also plays an important role to decide the customer service, technical support and the quality of an internet connection. There are various offers and service levels offered by AT&T to their users.

**V. CONCLUSIONS**

The findings of this study conclude that there are various network designs in home networking. However there is a need to plan a network so that the cost involved in selecting and planning a network should be kept low and all the devices within a home should get access to the internet. Since there are various types of internet connections available, thus various network equipments can be used to design a smart network, so that the cost involved is utilized up to the maximum. Moreover a smart design can secure a network also by keeping intruders from accessing the authorized data

and the network access either wired or wireless can be provided to all the devices within a home. Thus if a home network is designed properly, then the setup cost and maintenance cost will be very low and the design of a home network will last for a long time.

#### **ACKNOWLEDGMENT**

We take this opportunity to express our deepest gratitude and appreciation to all those who have helped us directly or indirectly towards the successful completion of this paper.

#### **REFERENCES**

- [1] O'Brien, J., Rodden, T., Rouncefield, M., Hughes, J. (1999) At home with the technology: an ethnographic study of a set-top-box trial. *ACM Trans. Comput.-Hum. Interact.*, 6 (3).282-308.
- [2] Rodden, T., Benford, S. (2003) The evolution of buildings and implications for the design of ubiquitous domestic environments. In *Proceedings of Conference on Human Factors in Computing Systems (CHI 03)*. 9-16.
- [3] Bell, G., Blythe, M., Sengers, P. (2005) Making by making strange: Defamiliarization and the design of domestic technologies. *ACM Trans. Comput.-Hum. Interact.*, 12 (2). 149-173.
- [4] Vitalari, N.P., Venkatesh, A., Gronhaug, K. (1985) Computing in the Home: Shifts in the Time Allocation Patterns of Households. *Communications of the ACM*, 28 (5). 512-522.
- [5] Consolvo, S., Roessler, P., Shelton, B.E. (2004) The CareNet Display: Lessons Learned from an In Home Evaluation of an Ambient Display. In *Proc. UbiComp 2004*. 1-17.
- [6] J.-Y. S. Marshini Chetty and R. E. Grinter. How smart homes learn: The evolution of the networked home and household. In *Proceedings of UbiComp 2007, Innsbruck, Austria, 2007*.
- [7] Taylor, A.S., Swan, L. (2005) Artful systems in the home In *Proceedings of Conference on Human Factors in Computing (CHI 05) Systems*, 641-650,
- [8] Kiesler, S., Lundmark, V., Zdaniuk, B., Kraut, R.E. (2000) Troubles with the Internet: The dynamics of help at home. *Human Computer Interaction*, 15 (4). 323-351.
- [9] Grinter, R.E., Ducheneaut, N., Edwards, W.K., Newman, M. (2005) The Work To Make The Home Network Work. In *Proc. Ninth European Conference on Computer-Supported Cooperative Work (ECSCW 05)*. 469-488.
- [10] Harper, R. (2003) *Inside the Smart Home*. Springer-Verlag, London.