



## Digital Filter Design Techniques of Microwave Filters

Mudasir Bashir

School of Electronics and Communication Engineering,  
Shri Mata Vaishno Devi University, Katra, J&K., India.

**Abstract:** Design techniques of microwave filters have been one of the major issues in Radio frequency circuit design. Though sincere effort has been made in this field but still the procedures employed are a bit cumbersome and tedious to work with. In this paper, an alternate way of designing microwave filters has been presented by implementing the well established and readily available digital filter design techniques. Emphasis has been basically led on the conversion of given microwave filter specifications to demanding digital specifications i.e. the poles and zeros are calculated for the analog frequency response of given microwave filter. From the poles and zeros, the microwave filter can be realized using conventional digital filter design techniques. For the sake of demonstration, response of a low pass filter with user-defined specification over independent pass and stop bands has been simulated and later on tested in microstrip technology.

**Index Terms:** Microwave filter, Digital signal processing techniques, matching, bilinear transformation technique (BLT), WIPL-D Microwave circuit simulator.

### I. Introduction

Filters are at the heart of many design problems. They are used to separate or combine different frequencies, as in frequency converters or multipliers, or in multiplex communications. The electromagnetic spectrum is limited and has to be shared; filters are used to confine the radiation from high-power transmitters within assigned spectral limits; conversely, other filters are used to protect receivers from interference outside their operating bands. The design of microwave and millimeter-wave devices requires more and more accurate synthesis procedures to satisfy the increasingly stringent specifications of modern communication systems [1]. In particular, as far as microwave filters are concerned, both in the past [2]–[6] and in recent years [7]–[12], a great effort has been devoted to the development of efficient design procedures. Most of the available synthesis techniques are based on models that do not conveniently describe the physical behavior of the filter (as, e.g., in the case of low-pass prototypes). Generally, the frequency response of the structure designed by these techniques does not match the specifications so that a numerical optimization process is necessary to obtain the final configuration of the filter. In recent times, the availability of high-power computational resources has made this approach possible and has led to the development of computer-aided design (CAD) tools based on different methods, such as the mode-matching method [13], the adjoint network method [14], and the space-mapping technique [15]. Frequency Selective Microwave filters such as low-pass, high-pass or band-pass filters can be devised with different frequency responses in different forms. The configuration and values of lumped elements of microwave filters can be simply obtained using conventional image-parameter or insertion loss design methods [16]–[18]. Richard's transformation can be used to emulate the inductive and capacitive behavior of the components in the transmission line (stubs of same electric length) and then Kuroda's identities can be used to facilitate the conversion between the various transmission line realizations [16]–[19]. Though these methods are abundantly used these days, but they suffer from three significant problems: 1. Matching source and load impedance to image impedance is not practical. 2. Image attenuation and phase shift values are not correct when source and load impedances are resistive. 3. Filter-response shape degradation due to incidental dissipation is not readily predictable [20]–[23]. As the electrical length of the stub and transmission-line are made equal and are cascaded orderly, therefore these parameters can be represented as functions of delay operators. Although many such techniques are applied for the schematic design of microwave filters [20]–[23], with many shortcomings. In this paper, simple and well established digital filter design techniques [24]–[26] are proposed by which we can synthesize microwave filters of demanding magnitude response. The main idea behind these techniques is to convert the given analog parameters of microwave filters into digital one's after which a designer can utilize digital signal processing techniques, without dealing with the complex calculations involved. One of these techniques is Bilinear transformation technique [24] with the help of which designing technique of microwave filter will be explained.

### II. Microwave Filter Design

Digital Signal Processing affords greater flexibility, higher performance (in terms of attenuation and selectivity), better time and environment stability and lower equipment production costs than traditional analog techniques. Digital filtering is one of the most powerful tools of Digital Signaling Processing. Digital filters are capable of performing that specifications which are extremely difficult, to achieve with an analog implementation. In addition, the characteristics of a digital filter can be easily changed under software control. The design technique can be achieved by following these

steps[24] as shown in Fig.1.:

1. Obtaining the digital design specifications from the given analog design specifications of a microwave filter by using BLT.
2. Designing the filter using compatible software.
3. Using INVERSE BLT to obtain pursued analog filter from the digital filter.

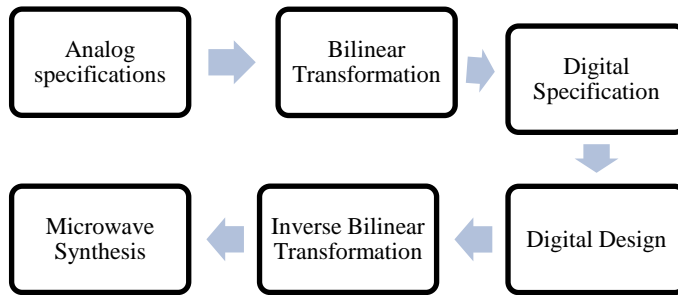

**Fig. 1: Proposed Design Technique**

**A. From Analog Domain to Digital Domain**

One important application of the bilinear transformation is for the conversion of an analog filter to a digital one. The transformation is applied as follows. Start from a Laplace domain filter  $H_a(s)$  which is a rational function in the free variable  $s$ . A rational transfer function is the quotient of two polynomials. The bilinearly transformed discrete time transfer function  $H_d[z]$  is defined as[21]:

$$H_d[z] = H_a(s) \quad \left| \quad s = a \frac{z-1}{z+1} \quad (1)$$

i.e.  $s = a \frac{z-1}{z+1} \quad (2)$

where  $a = \frac{2\pi \cdot fp}{\tan(\pi \frac{fp}{fs})}$ ,  $z = e^{j\omega}$  and  $s = j2\pi \cdot f$

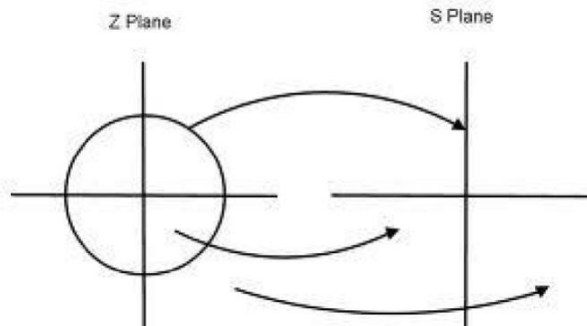

Fig.2: Mapping between z-plane and s-plane

Above equations provide an algebraic relation between the analog Laplace transform s-plane and the digital z-transform plane as shown in Fig. 2. The bilinear transformation employs two parameters: 1) the sampling frequency  $fs$ , which must satisfy Nyquist criterion and 2) the pre-wrapping frequency  $fp$ , which can be fixed to make the digital requirements more relaxed[24]. To demonstrate the proposed design methodology, a model of low pass filter (Chebyshev approximation) with specification and design parameters as shown in Table 1. are implemented.

**TABLE 1 - FILTER SPECIFICATION (SPEC) AND DESIGN PARAMETERS**

Spec. Parameters	Value [Unit]	Design Parameters	Value [Unit]
Freq. Pass	1 [GHz]	Filter order	5
Freq. Stop	1.4 [GHz]	R source	50[Ohms]
Pass-band attenuation	1[dB]	R load	50[Ohms]
Stop-band attenuation	20[dB]	Ripple factor	1 [dB]

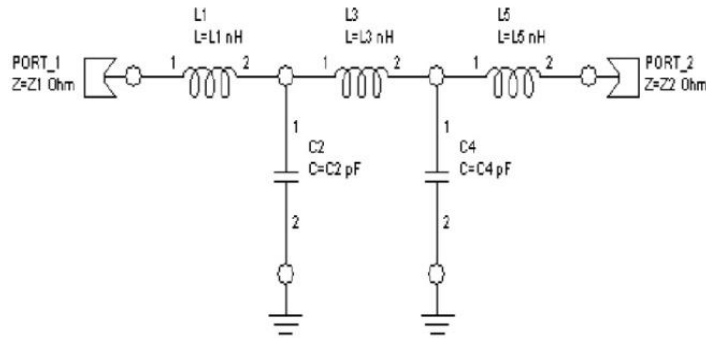

Fig. 3: LC ladder low pass filter

**B. Digital Design**

There are many efficient techniques to design a digital filter satisfying the (digital) specifications obtained in the above subsection. Furthermore, they are readily accessible and subject to a continuous improvement. In this paper, iterative quasi-Newton type algorithm, available in MATLAB is used [22]-[27] (Fig.4). The algorithm provides some parameters that allow us to control the design process with high flexibility. The most relevant ones are the filter order, the weighting vector and the range of values for the error function. As a result, the poles and zeros of the digital filter are obtained (Fig. 5).

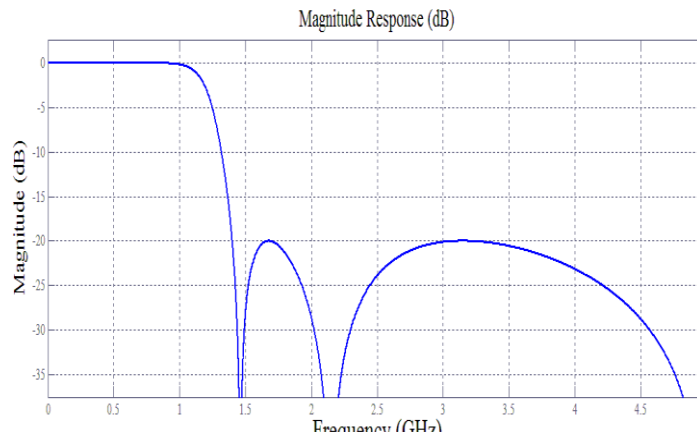

Fig. 4. Digital frequency response of low pass filter

**C. Digital to Analog conversion**

For transformation of classical analog filters into digital filters, the bilinear transformation technique as used in Section II-A is usually employed. Now Inverse bilinear transformation technique will be used to transform the digital filter back into the pursued analog filter.

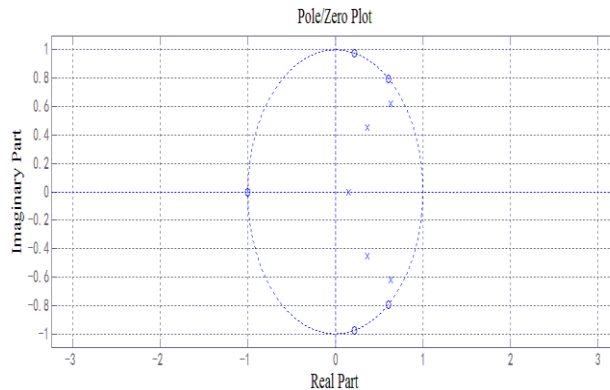

Fig. 5: Pole-zero plot of frequency response

This inverse relation transforms z-plane to s-plane according to the following equation [21].

$$z = \frac{a+s}{a-s} \quad (3)$$

From above formula analog poles and zeros can be obtained from the corresponding digital poles and zeros (Fig. 2).

**D. Design of the Microwave Filters**

The above result obtained is converted into a transfer function  $S_{21}$  of desired response of analog filter. The LC ladder network that implements this frequency response is shown in Fig. 3. The parameters can be calculated by using the insertion loss method [20]. The inductor values in nH are :  $L1=L5=11.3$ ,  $L3=16.85$ , and those of capacitors in pF are :  $C2=C4=3.26$ . Three models of a low-pass filter, derived from the same specifications, are created using Filter Designer. The first model is implemented as a LC ladder (Fig 3), the second as transmission line (Tx) stubs and the third model is implemented as a microstrip stub filter . These three models are simulated in WIPL-D Microwave circuit simulator using closed-form equation components [20][27]. A simulation-ready circuit model in WIPL-D Microwave is automatically generated based on Filter Designer output. Dielectric characteristics for the microstrip model are given in Table. 2.  $H$  is substrate height,  $T_g D$  is loss tangent, while  $T$  is metallization thickness.

TABLE 2 DIELECTRIC CHARACTERISTIC

Parameter	Values [Unit]
$\epsilon_e$	3.38
H	0.508 [mm]
$\sigma$	58.8 [MS/m]
$T_g D$	0.0027
T	0.017 [mm]

Frequency range of interest is from 0.014 GHz up to 2.8 GHz, and it is scanned in 40 points in simulations. Parameters  $S_{11}$  and  $S_{21}$  of the LC, microstrip and transmission line circuit models are shown in Figs 6-7. Microstrip closed-form component models were used in the corresponding circuit model (Fig. 4).

### III. Result

While comparing the results of microwave low pass filter from both the techniques from Fig.4 and Fig.7, I concluded that the output magnitude response of both these techniques were almost similar. Hence, we can use digital signal processing techniques to design a microwave filter as an alternative technique which later on can be implemented in a particular application.

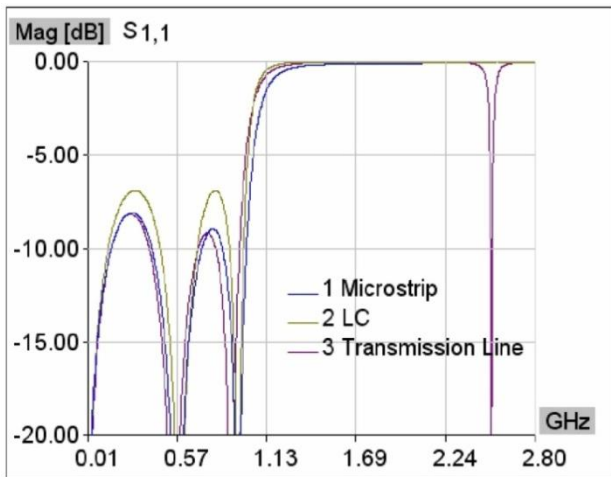

FIG. 6:  $S_{11}$  Parameter of LC, Tx and microstrip models in WIPL-D microwave circuit simulator

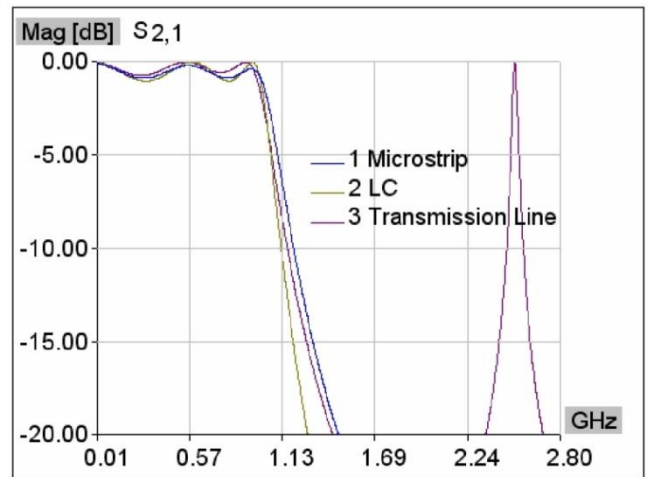

FIG. 7:  $S_{21}$  parameter of LC, Tx and microstrip models in WIPL-D microwave circuit simulator

### IV. Conclusion

In this paper, I have tried to show an alternate technique of designing microwave filters using digital filter design technique, with the help of simulations, that instead of complex and tedious techniques usually employed for microwave filter designing we can implement the digital signal processing techniques. However the said idea can be application specific. Hence these techniques can be used in various technologies/applications for microwave filter designing and can result as a better solution for designers in this innovative world.

### References

- [1] C. Kudsia, R. Cameron, and W.-C. Tang, "Innovations in microwave filters and multiplexing networks for communication satellite systems," *IEEE Trans. Microwave Theory Tech.*, vol. 40, pp. 1133–1149, June 1992.
- [2] R. J. Cameron, "General prototype network-synthesis methods for microwave filters," *ESA J.*, vol. 6, no. 2, pp. 193–206, 1982.
- [3] *IEEE Trans. Microwave Theory Tech.*, vol. 30, July 1994.
- [4] A. Abdelmonem, J.-F. Liang, H.-W. Yao, and K. A. Zaki, "Full-wave design of spurious free D.R. TE mode band pass filters," *IEEE Trans. Microwave Theory Tech.*, vol. 43, pp. 744–752, Apr. 1995.
- [5] *International Journal Microwave Millimeter Wave Computer-Aided Eng.*, vol. 7, no.2/3, March/May 1997.

- [6] R. Levy and S. B. Cohn, "A history of microwave filter research, design and development," *IEEE Trans. Microwave Theory Tech.*, vol. MTT-32, pp. 1055–1067, Sept. 1984.
- [7] Jong-sik Lim, Chul-soo Kim, Dal Ahn, Yong-chaе Jeong, and Sangwook Nam, "Design of Low-Pass Filter Using Defected Ground Structure", *IEEE transactions on microwave theory and techniques*, vol. 53, no. 8, pp.2539-2545, August, 2005
- [8] R. Levy, R. V. Snyder, and G. Matthaei, "Design of microwave filters," *IEEE Trans. Microwave Theory Tech.*, vol. 50, no. 3, pp.783–793, 2002
- [9] A. Monorchio, G. Manara, U. Serra, G. Marola, and E. Pagana, "Design of waveguide filters by using genetically optimized frequency selective surfaces," *IEEE Microw. Wireless Compon. Lett.*, vol. 15, no. 6, pp. 407–409, Jun. 2005.
- [10] S. Chahravarty and R. Mittra, "Design of microwave filters using a binary coded genetic algorithm," in *Proc. IEEE Antennas and Propag. Society Int. Symp.*, 2000, vol. 1, pp. 144–147.
- [11] J.-W. Sheen, "A compact semi-lumped low-pass filter for harmonics and spurious suppression," *IEEE Microw. Guided Wave Letter*, vol. 10, no. 3, pp 92-93, March. 2000.
- [12] Levy R., Snyder R. V. and Matthaei G., "Design of Microwave Filter"s, *IEEE Trans. Microwave Theory Tech.*, vol. 50, No. 3, pp. 783-793, Mar. 2002.
- [13] M. Guglielmi, "Simple CAD procedure for microwave filters and multiplexers," *IEEE Trans. Microwave Theory Tech.*, vol. 42, pp. 1347–1352, July 1994.
- [14] Irina B. Vendik, Orest G. Vendik, Anatoli N. Deleniv, Vassili V. Kondratiev, Maria N. Goubina, and Dmitri V. Kholodniak, "Development of CAD Tool for a Design of Microwave Planar HTS Filters", *IEEE Transactions on Microwave Theory and techniques*, Vol. 48, No. 7, pp. 1247-1255, July 2000.
- [15] F. Alessandri, M. Mongiardo, and R. Sorrentino, "New efficient full wave optimization of microwave circuits by the adjoint network method," *IEEE Microwave Guided Waves Lett.*, vol. 3, pp. 414–416, Nov. 1993.
- [16] J. W. Bandler, A. I. Mostafa, J. E. Rayas-Sánchez, and Q. J. Zhang, "Neuro modeling of Microwave Circuits Exploiting Space-Mapping Technology," *IEEE Trans. Microwave Theory Tech.*, vol.42, pp.2417–2427, Dec. 1999.
- [17] Reinhold Ludwig, Gene Bogdanov, *RF Circuit Design: Theory and Applications*, 2<sup>nd</sup> ed., Pearson Education, 2009, pp.205-268.
- [18] M. Korber, "New Microstrip Filter Topologies," *Microwave Journal*, 40 pp.138-144, 1997.
- [19] Z. Milosavljevid, M. Gmitrovid, "New Kuroda's Identities", *Proceed. of the XLI Conf. ETRAN*, pp. 480-483, Zlatibor, Yugoslavia, 1997 (in Serbian).
- [20] D. M. Pozar, "Microwave Engineering," Wiley, 2007, pp.422-470.
- [21] R.M. Kurzrok, "Low Cost Lowpass Filter Design Using Image Parameters," *Applied Microwave & Wireless*. Pp.72 and 74, Feb.1999.
- [22] R.M. Kurzrok, correction, *Applied Microwave & Wireless*, p. 12, May 1999.
- [23] M. Salerno, R. Sorrentino, and F. Giannini, "Image Parameter Design of Non-Commensurate Distributed Structures: An Application to Microstrip Low-Pass Filters," *IEEE Transactions MTT*, Vol. MTT-34, pp.58-65, January 1986.
- [24] John G. Proakis, Dimitris G. Manolakis. *Digital Signal Processing*, Pearson Education, 2007, pp.654-735.
- [25] Zerev A. I., *Handbook of Filter Synthesis*, John Wiley and Sons, New York, 1967.
- [26] Steven W. Smith, "The Scientist's and Engineer's Guide to Digital Signal Processing," 2nd ed., California Technical Publication, 1999, pp. 261-296.
- [27] <http://www.mathworks.in/help-> [online source].
- [28] B. M. Kolundžija, J. S. Ognjanović, T. K. Sarkar, D. S. Šumić, M. M. Paramentić, B. B. Janjić, D. I. Olćan, D. V. Tošić, M. S. Tasić, *WIPL-D Microwave – Software and User's Manual*, Artech House, USA, 2005.